

# SONY®

# IC Recorder

---

## Operating Instructions

### Owner's Record

The model number is located at the rear panel and the serial number is located inside the battery compartment. Record the serial number in the space provided below. Refer to these numbers whenever you call upon your Sony dealer regarding this product.  
Model No. ICD-SX57  
Serial No. \_\_\_\_\_

# IC RECORDER

## ICD-SX57

© 2007 Sony Corporation

2-894-353-52 (1)

Getting Started

Basic Operations

Various Recording Modes

Playback/Erasing

Editing Messages

Utilizing the Menu Function

Using the IC Recorder with Your Computer

**Troubleshooting**

Additional Information

**Index**

## For the customers in the United States

The following FCC statement applies only to the version of this model manufactured for sale in the USA. Other versions may not comply with FCC technical regulations.

### INFORMATION

This equipment has been tested and found to comply with the limits for a Class B digital device, pursuant to Part 15 of the FCC Rules. These limits are designed to provide reasonable protection against harmful interference in a residential installation. This equipment generates, uses and can radiate radio frequency energy and, if not installed and used in accordance with the instructions, may cause harmful interference to radio communications.

However, there is no guarantee that interference will not occur in a particular installation. If this equipment does cause harmful interference to radio or television reception, which can be determined by turning the equipment off and on, the user is encouraged to try to correct the interference by one or more of the following measures:

- Reorient or relocate the receiving antenna.
- Increase the separation between the equipment and receiver.
- Connect the equipment into an outlet on a circuit different from that to which the receiver is connected.
- Consult the dealer or an experienced radio/TV technician for help.

You are cautioned that any changes or modifications not expressly approved in this manual could void your authority to operate this equipment.

If you have any questions about this product, you may call: Sony Customer Information Services Center 1-800-222-7669 or <http://www.sony.com/>

### Declaration of Conformity

Trade Name : SONY  
Model : ICD-SX57  
Responsible Party : Sony Electronics Inc.  
Address : 16530 Via Esprillo, San Diego,  
CA 92127 USA  
Telephone Number : 858-942-2230

This device complies with part 15 of the FCC Rules. Operation is subject to the following two conditions: (1) This device may not cause harmful interference, and (2) this device must accept any interference received, including interference that may cause undesired operation.

### For the State of California, USA only

Perchlorate Material — special handling may apply, See [www.dtsc.ca.gov/hazardouswaste/perchlorate](http://www.dtsc.ca.gov/hazardouswaste/perchlorate)  
Perchlorate Material : Lithium battery contains perchlorate

---

## Notice for users

Program © 1999, 2000, 2001, 2002, 2003, 2004, 2005, 2006, 2007 Sony Corporation  
Documentation ©2007 Sony Corporation

All rights reserved. This manual or the software described herein, in whole or in part, may not be reproduced, translated or reduced to any machine readable form without prior written approval from Sony Corporation.

IN NO EVENT SHALL SONY CORPORATION BE LIABLE FOR ANY INCIDENTAL, CONSEQUENTIAL OR SPECIAL DAMAGES, WHETHER BASED ON TORT, CONTRACT, OR OTHERWISE, ARISING OUT OF OR IN CONNECTION WITH THIS MANUAL, THE SOFTWARE OR OTHER INFORMATION CONTAINED HEREIN OR THE USE THEREOF.

Sony Corporation reserves the right to make any modification to this manual or the information contained herein at any time without notice.

The software described herein may also be governed by the terms of a separate user license agreement.

- This software is for Windows and cannot be used for Macintosh.
- The supplied connecting cable is for the IC recorder ICD-SX57. You cannot connect other IC recorders.

## Information

IN NO EVENT SHALL SELLER BE LIABLE FOR ANY DIRECT, INCIDENTAL OR CONSEQUENTIAL DAMAGES OF ANY NATURE, OR LOSSES OR EXPENSES RESULTING FROM ANY DEFECTIVE PRODUCT OR THE USE OF ANY PRODUCT.

## Trademarks

- Microsoft, Windows, Outlook, DirectX are registered trademarks or trademarks of the Microsoft Corporation in the United States and/or other countries.
- Apple and Macintosh are trademarks of Apple Computer Inc., registered in the USA and other countries.
- Pentium is a registered trademark of Intel Corporation.
- Intel Core is a trademark or a registered trademark of Intel Corporation.
- Dragon Speech, Dragon NaturallySpeaking are trademarks owned by Nuance Communications, Inc. and are registered in the United States and/or other countries.
- MPEG Layer-3 audio coding technology and patents licensed from Fraunhofer IIS and Thomson.
- "Memory Stick" and  are trademarks of Sony Corporation.

- "Memory Stick Duo" and **MEMORY STICK DUO** are trademarks of Sony Corporation.
- "Memory Stick PRO Duo" and **MEMORY STICK PRO DUO** are trademarks of Sony Corporation.
- "MagicGate Memory Stick" is the trademark of Sony Corporation.
- "LPEC" and **LPECE** are registered trademarks of Sony Corporation.
- US and foreign patents licensed from Dolby Laboratories.



Music Identification Technology and associated data will be supplied from the Gracenote®. Gracenote MusicID is the industry standard for digital music identification for both CDs and individual music files. For details, see the following web site: [www.gracenote.com](http://www.gracenote.com)

Gracenote® is a registered trademark of the Gracenote, Inc. The Gracenote logo and logotype, and "Powered by Gracenote" logo are trademarks of the Gracenote. For use of the Gracenote services, see the following web page: [www.gracenote.com/corporate](http://www.gracenote.com/corporate)

All other trademarks and registered trademarks are trademarks or registered trademarks of their respective holders. Furthermore, "™" and "®" are not mentioned in each case in this manual.

The "Digital Voice Editor" uses software modules as shown below:  
Microsoft® DirectX®  
©2001 Microsoft Corporation. All rights reserved.

---

## Table of Contents

Checking the contents of the package.....	7
Index to Parts and Controls.....	8

---

## Getting Started

Step 1: Preparing a Power Source .....	13
Installing the batteries.....	13
When replacing/charging the batteries.....	15
Step 2: Setting the Clock.....	17
Step 3: Preparations Required before Recording.....	19

---

## Basic Operations

Recording Messages.....	21
-------------------------	----

---

## Various Recording Modes

Manual Recording Mode.....	24
Starting to Record Automatically in Response to Sound – the VOR Function .....	25

Adding a Recording to a Previously Recorded Message.....	26
Adding an Overwrite Recording during Playback.....	28
Dividing a Message into Two during Recording .....	29
Recording with an External Microphone .....	30
Recording from Other Equipment.....	31
Recording sound from a telephone or a cell phone .....	32

---

## Playback/Erasing

Playing Back Messages.....	33
Adjusting the playback sound by amplifying inaudible sound – the Digital Voice Up function....	36
Adjusting the playback speed – DPC (the Digital Pitch Control function) .....	37
Playing Back a Specified Section Repeatedly – A-B Repeat .....	37
Adding a Bookmark .....	38

Playing Back a Message at a Desired Time with an Alarm .....	39
Erasing Messages.....	42
Erasing Messages one by one .....	42
Erasing All Messages in a Folder .....	43

---

## **Editing Messages**

Dividing a Message into Two.....	44
Moving Message to a Different Folder .....	45
Adding Priority Mark(s) – the Priority Mark Function .....	45

---

## **Utilizing the Menu Function**

Making Settings for the Menu.....	46
-----------------------------------	----

---

## **Using the IC Recorder with Your Computer**

Using the Supplied Digital Voice Editor Software.....	57
What You Can Do Using the Digital Voice Editor Software.....	57
System Requirements.....	58
Installing the Software.....	59
Connecting the IC Recorder to your Computer .....	61
Referring to the Help Files.....	62
Playing Back MP3 Files Using the IC Recorder .....	62
Using the Digital Voice Editor Software .....	63
Using Windows Explorer.....	63
Construction of folders and files.....	64
Using the IC Recorder as a USB Mass Storage Device.....	65

---

## Troubleshooting

Troubleshooting.....	66
Error Messages (IC recorder).....	73
System Limitations .....	76

---

## Additional Information

Recording with Other Equipment .....	77
Using a USB AC Adaptor (not supplied) .....	78
Precautions.....	79
Specifications .....	80
Index.....	82

---

# Checking the contents of the package

IC Recorder (1)

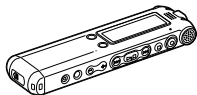

LR03 (size AAA) alkaline batteries (2)

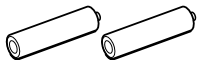

Stereo ear receiver (1)

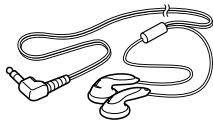

Application Software, Digital Voice Editor (CD-ROM) (1)

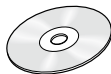

USB connecting cable (1)

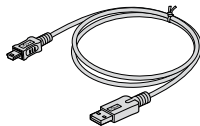

Carrying pouch (1)

Operating Instructions (1)

Warranty (1)

# Index to Parts and Controls

Refer to the pages indicated in parentheses for details.

## Front

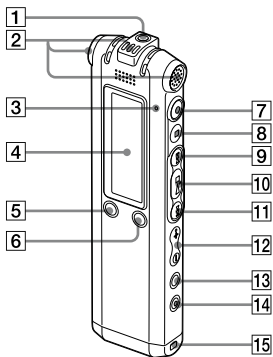

- 1**  $\Omega$  (headphone) jack\* (23, 34, 77)
- 2** Built-in microphones (stereo/directional) (21, 24)
- 3** Operation indicator (21, 24, 26, 28)

- 4** Display window (10, 11)
- 5** DIVIDE/ $\blacklozenge$  (bookmark) button (30, 33, 38)
- 6**  $\text{[Folder]}$ /MENU button
- 7**  $\bullet$  (record/pause) button (21, 24, 25, 26, 28)
- 8**  $\blacksquare$  (stop) button (17, 21, 24, 26, 28, 33, 40, 42, 45, 46)
- 9**  $\blacktriangleright\blacktriangleright$  (cue/fast forward) button (34)
- 10**  $\blacktriangleright\blacksquare$  (play/stop/enter) button
- 11**  $\blacktriangleleft\blacktriangleleft$  (review/fast backward) button (34)
- 12** VOL (volume) +/- button (23, 33)
- 13**  $\blackleftarrow$  (repeat) A-B/ $\star$  (priority) button (33, 37, 45)
- 14** ERASE button (42)
- 15** Opening for a handstrap (A handstrap is not supplied.)



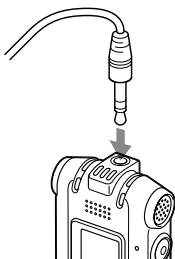

\* Connect stereo ear receiver or stereo headphones supplied or not supplied to the  (headphone) jack. If unwanted noise is heard, wipe the headphones plug clean.

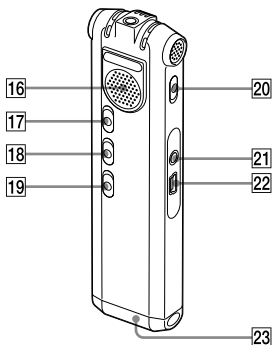

## Rear



- 16 Speaker
- 17 HOLD switch\*\*
- 18 V-UP (Digital Voice Up) switch (36)
- 19 DPC switch (37)
- 20 DIRECTNL (directional) switch (23)
- 21  (microphone) jack (30, 31)
- 22  (USB) connector (13, 61)
- 23 Battery compartment (13)

\*\* Slide the HOLD switch in the direction of the arrow to lock all the functions of all the buttons. During stop, "POWER SAVING..." will be displayed and the display will be turned off to prevent battery power from exhausting.

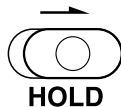

## Display window

### Display during playback and stop

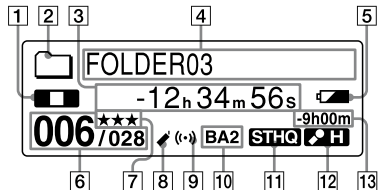

- 1** Operation mode indicator  
Displays the following, depending on the current operation mode  
 : playback  
 : stop  
 : review/fast backward, cue/fast forward  
 : going backward/forward continuously
- 2** Folder indicator
- 3** Elapsed time/Remaining time indication/Recording date and time indication
- 4** Folder name/Message name/Artist name indication

- 5** Remaining battery/Charging indicator  
When dry batteries are used, the indicator shows the remaining battery power.  
While charging the rechargeable batteries an animation appears.
- 6** Selected message number/Total number of messages in the folder
- 7** Priority marks  
Appear(s) when a message is set with priority mark(s).
- 8** Bookmark indicator  
Appears when a bookmark is set for a message.
- 9** Alarm indicator  
Appears when the alarm is set for a message.
- 10** Sound effect indicator  
Displays the EFFECT setting in the menu.  
BA1 : The bass sound is reinforced.  
BA2 : The bass sound is further reinforced.

- 11** Recording mode indicator  
 Displays the recording mode set using the menu when the IC recorder is in the stop mode, and displays the current recording mode when the IC recorder is in the playback mode.

STHQ : Standard play stereo recording mode with high quality sound

ST : Standard play stereo recording mode

STLP : Long play stereo recording mode

SP : Standard play monaural recording mode

LP : Long play monaural recording mode

MP3 : MP3 mode (during playback only)

- 12** Microphone sensitivity indicator  
 Displays the current microphone sensitivity.
- H** (high) : To record at a meeting or in a quiet/spacious place.
  - L** (low) : To record for dictation or in a noisy place.
- MAN (manual) : To record with microphone sensitivity set manually.

- 13** Remaining recording time indication

## Display during recording

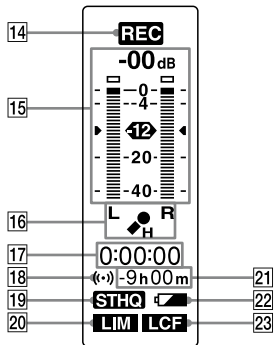

- 14** Operation mode indication  
 Displays the following, depending on the current operation of the IC recorder.

**REC** : recording

●**II** : recording standby/recording pause

**REC VOR** : recording with the VOR function

●**II VOR** : recording pause with the VOR function

- 15** Recording level meter

- 16** Microphone sensitivity indicator  
Displays the current microphone sensitivity when recording with AGC (Automatic Gain Control).  
◆**H** (high) : To record at a meeting or in a quiet/spacious place.  
◆**L** (low) : To record for dictation or in a noisy place.  
Displays the recording level during manual recording.
- 17** Elapsed recording time indication
- 18** Alarm indicator
- 19** Recording mode indicator  
Displays the recording mode (STHQ, ST, STLP, SP, and LP) set in the menu.
- 20** LIM (limiter) indicator  
Displays the LIMITER setting in the menu.  
When "REC LEVEL" is set to "AUTO-AGC," "--" is displayed.
- 21** Remaining recording time indication
- 22** Remaining battery/Charging indicator
- 23** LCF (Low Cut Filter) indicator  
Displays the LCF setting in the menu.

# Step 1: Preparing a Power Source

## Installing the batteries

- 1 Slide and lift the battery compartment lid.

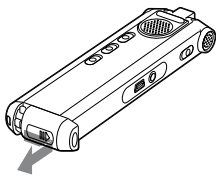

- 2 Insert two LR03 (size AAA) alkaline batteries with correct polarity, and close the lid.

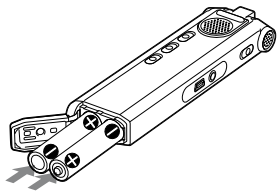

Clock setting display appears when you insert batteries for the first time, or when you insert batteries after the IC recorder has been without batteries for a certain period of time. Please refer to step 4 in “Step 2: Setting the Clock” on page 17 to set the date and time.

## Using rechargeable batteries

You can install rechargeable batteries (not supplied) instead of the supplied batteries.

Follow steps 1 and 2, and then charge the batteries by connecting the USB connector of the IC recorder to your computer.

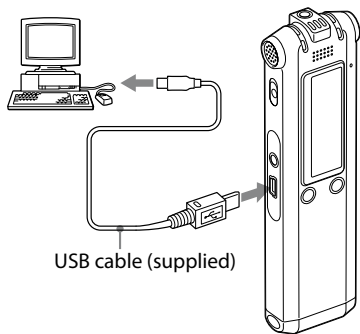

While the batteries are charging, "CONNECTING" and the battery indicator are displayed in an animation.

When the battery indicator indicates "FULL," charging is completed. (Charging time: approx. 4 hours\*)

When you use the IC recorder for the first time, or after you have not used the IC recorder for a certain time, it is recommended that you charge the batteries repeatedly until "FULL" is displayed.

If the battery indicator is not displayed, charging has not been done properly. Proceed from step 1 again.

\* This is an approximation for the time it takes to charge from no remaining battery power to full battery power at room temperature. It varies depending on the remaining power and the condition of the batteries. It also takes more time if the temperature of the batteries is low, or if the batteries are changed while you are transferring data to the IC recorder.

### Tip

You can charge the rechargeable batteries by connecting the IC recorder to an AC outlet using a USB AC adaptor (not supplied) (page 78).

### Notes

- While "COLD" or "HOT" is being displayed instead of the remaining battery/charging indicator, you cannot charge the batteries. Charge the batteries in an environment with a temperature of 5 °C – 35 °C.
- If "USB CHARGE" in the menu "DETAIL MENU" is set to "OFF," you cannot charge the batteries using your computer. Set "USB CHARGE" to "ON" (page 56).
- Do not use manganese batteries for this IC recorder.

Clock setting display appears when you insert batteries for the first time, or when you insert batteries after the IC recorder has been without batteries for a certain period of time. Please refer to step 4 in "Step 2: Setting the Clock" on page 17 to set the date and time.

## When replacing/charging the batteries

The battery indicator on the display window shows the battery condition.

### Notes

- Do not use manganese batteries for this IC recorder.
- When you replace the batteries, insert the new ones within 3 minutes after you remove the exhausted ones. Otherwise, the display may show the clock setting display or incorrect date and time when you re-insert the batteries. In this case, set the date and time again. The recorded messages and alarm setting, however, will remain.
- Do not charge dry batteries.
- When you are not going to use the IC recorder for a long time, remove the batteries to prevent damage from battery leakage and corrosion.

### Battery remain indication

: Replace the old batteries with new ones or charge both batteries.



: "LOW BATTERY" appears and the IC recorder will stop operation.

### Battery life\*1

When using a Sony LR03 (SG) (size AAA) alkaline battery

Recording mode	STHQ*3	ST*4
Recording	Approx. 13 hr. 30 min.	Approx. 14 hr. 30 min.
Playback*2 through speaker	Approx. 16 hr. 30 min.	Approx. 17 hr.
Playback using ear receiver	Approx. 22 hr.	Approx. 23 hr.

Recording mode	STLP*5	SP*6
Recording	Approx. 16 hr. 30 min.	Approx. 17 hr.
Playback*2 through speaker	Approx. 17 hr. 30 min.	Approx. 19 hr.
Playback using ear receiver	Approx. 24 hr. 30 min.	Approx. 27 hr. 30 min.

Recording mode	LP <sup>7</sup>	MP3 (128 Kbps/44.1 kHz)
Recording	Approx. 19 hr.	–
Playback <sup>2</sup> through speaker	Approx. 19 hr. 30 min.	Approx. 17 hr. 30 min.
Playback using ear receiver	Approx. 28 hr. 30 min.	Approx. 24 hr.

(hr : hours/min. : minutes)

<sup>1</sup> The battery life may shorten depending on how you operate the IC recorder

<sup>2</sup> When playing back through the internal speaker with the volume level set to VOL12

<sup>3</sup> STHQ : Stereo high quality recording mode

<sup>4</sup> ST : Stereo standard recording mode

<sup>5</sup> STLP : Stereo long play recording mode

<sup>6</sup> SP : Standard play recording mode

<sup>7</sup> LP : Long play recording mode

## Note on the “UPDATING DATABASE...” message

The IC recorder is accessing data while “UPDATING DATABASE...” appears in the display window or the OPR indicator flashes in orange. While accessing, do not remove the batteries or USB AC adaptor (not supplied). Doing so may damage the data.

### Note

If the IC recorder is required to process excessive amount of data, “UPDATING DATABASE...” may be displayed for an extended period of time. This is not a malfunction of the IC recorder. Wait until the message disappears before starting operation.



## Step 2: Setting the Clock

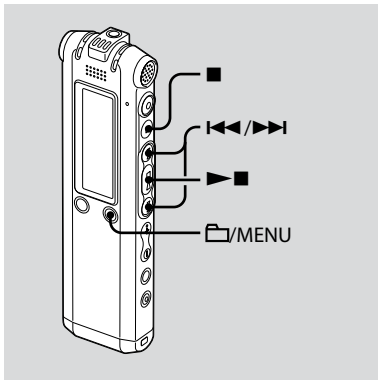

You need to set the clock to use the alarm function or record the date and time.

Clock setting display appears when you insert batteries for the first time, or when you insert batteries after the IC recorder has been without batteries for a certain period of time. In this case, proceed from step 4.

### 1 Select "DATE & TIME" in the menu.

- Press and hold /MENU.  
The menu mode will be displayed in the display window.



- Press or to select "DETAIL MENU" and press .
- Press or to select "DATE & TIME" and press .

### 2 Press or to select "AUTO" or "MANUAL" and press .

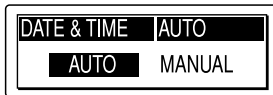

When you selected "AUTO," the clock is automatically adjusted using the clock in the computer connected to the IC recorder and on which the supplied Digital Voice Editor software is started. When you select "MANUAL," proceed to the next steps.

- 3 Press **◀◀** or **▶▶** to select “07y1m1d” and press **▶■**.

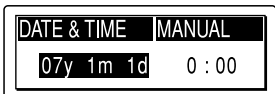

- 4 Press **◀◀** or **▶▶** to set the year, month, day, hour, and minute in sequence, and then press **▶■**.

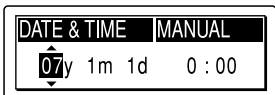

“EXECUTING...” appears and the clock is set.

- 5 Press **■** to return to the normal display.

**Note**

If you do not press **▶■** within one minute of entering the clock setting data, the clock setting mode is cancelled and the window will return to the normal display.

## Step 3: Preparations Required before Recording

### Recording at a meeting

- Set "MIC SENS" to "HIGH" in the menu (page 49).
- Slide the DIRECTNL switch to "ON" to record a voice coming from a specific direction (page 23).
- Set "LCF (LOW CUT)" to "ON" in the menu to prevent noise caused by a projector, etc. (page 49).

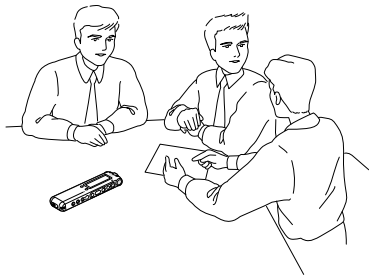

### Recording a musical performance

- Set "REC LEVEL" to "MANUAL" in the menu (page 50) to record more realistic sound, distinguishing dynamic sound and soft sound.
- Set "LIMITER" to "ON" in the menu (page 54), to prevent distortion when a loud sound is suddenly input.

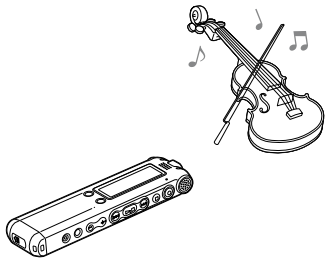

## Recording dictation (using the voice recognition software)

- Set “MIC SENS” to “LOW ” in the menu (page 49).
- Slide the DIRECTNL switch to “ON” to record a voice coming from a specific direction (page 23).
- To transcribe a message recorded on the IC recorder using voice recognition software (not supplied), set “REC MODE” to “STHQ,” “ST,” “STLP,” or “SP” (page 49).

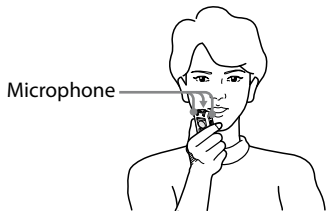

- Before you can transcribe recorded messages, you have to create a user file specifically adapted to the sound of your recorded speech. This procedure is called “training.” For details on “training,” refer to the help files supplied with the voice recognition software you are using.

- To obtain maximum recognition accuracy, hold the IC recorder so that the microphone is about an inch (2 - 3cm) from the corner of your mouth.
- To minimize the sound of your breath in the recordings, do not hold the microphone directly in front of your mouth.
- To obtain maximum recognition accuracy, avoid recording in a noisy place.
- You cannot transcribe a message recording the voices of more than one person.
- You can transcribe the following messages recorded using your IC recorder or files saved on your computer.
  - Messages recorded in the STHQ, ST, STLP or SP mode (DVF)
  - 44.1/16/11kHz 16-bit WAV files saved on the computer

# Recording Messages

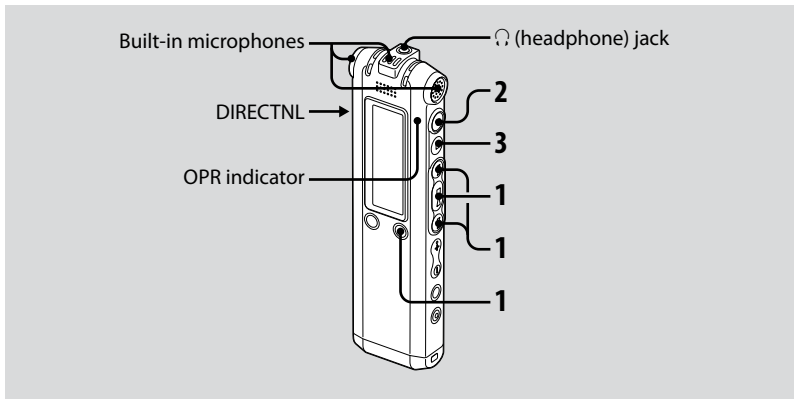

This section explains how to record using the AUTO\_AGC\* setting, to which the IC recorder is preset at the factory.

\* Auto Gain Control

## 1 Select a folder.

- ① Press /MENU to display the folder selection window.
- ② Press or to select the folder in which you want to record messages, and then press .

## 2 Start recording.

- ① Press (record).  
The OPR indicator lights in red and the window changes to the recording display (page 11).  
You do not need to press and hold (record) while recording. The new message will be automatically recorded after the last recorded message.
- ② Speak into the built-in microphone.

### 3 Press **■** (stop) to stop recording.

The IC recorder stops at the beginning of the current recording.

#### Tips

- When you purchase the IC recorder, there are 5 folders already available, and you can record up to 999 messages in each folder.
- By using the supplied Digital Voice Editor software, you can make new folders or delete unnecessary folders (page 57).

#### Notes

- While the OPR indicator is flashing or is lit in orange, do not remove the batteries or the USB AC adaptor. Doing so may damage the data.
- Noise may be recorded if an object, such as your finger, etc., accidentally rubs or scratches the IC recorder during recording.
- Before making a recording, be sure to check the battery indicator (page 15).
- To avoid replacing batteries during a long recording session, use the USB AC adaptor (not supplied).
- The maximum recording time and the number of messages you can make varies, depending on the conditions of use.

To	Do this
pause recording*	Press <b>●</b> (record). During recording pause, the OPR indicator flashes in red and “ <b>●■■</b> ” flashes in the display window.
release pause and resume recording	Press <b>●</b> (record). Recording resumes from that point. (To stop recording after pausing recording, press <b>■</b> (stop).)
review the current recording instantly**	Press <b>▶■</b> . Recording stops and playback starts from the beginning of the message just recorded.
review during recording**	Press and hold <b>◀◀</b> during recording or recording pause. Recording stops and you can search backwards while listening to fast playback sound. After you release <b>◀◀</b> , playback starts from that point. You can add an overwrite recording from that point.

- \* One hour after you pause recording, recording pause is automatically released and the IC recorder enters the stop mode.
- \*\* You cannot select this function in the manual recording mode.

## Selecting the recording mode

Select the recording mode in the “REC MODE” menu.

**STHQ :** High-quality stereo recording mode; you can record with stereo high-quality sound.

**ST :** Standard play stereo recording mode; you can record with stereo sound.

**STLP :** Long play stereo recording mode; you can record for a longer time with stereo sound.

**SP :** Standard play monaural recording mode; you can record with standard quality sound.

**LP :** Long play monaural recording mode; you can record for a longer time with monaural sound.

To record with better sound quality, select the STHQ or ST mode.

## Monitoring the recording

Connect the stereo ear receiver supplied to the  (headphone) jack and monitor the recording. You can adjust the monitoring volume by pressing VOL + or VOL –, but the recording level is fixed.

## Maximum recording time

The maximum recording time of all the folders is as follows.

<b>STHQ mode</b>	<b>ST mode</b>	<b>STLP mode</b>
4 hr. 10 min.	11 hr. 10 min.	21 hr. 35 min.
<b>SP mode</b>	<b>LP mode</b>	
34 hr. 15 min.	91 hr. 20 min.	

## Recording a sound centering on a specific direction

To record a sound centering on a specific direction, slide the DIRECTNL switch to the “ON” position. This is convenient when you want to record a particular sound at a conference/meeting, etc.

In this case, even when you select the stereo recording mode (STHQ, ST, or STLP mode), the sound is recorded in the monaural mode. When you are using an external microphone, the DIRECTNL switch does not function.

# Manual Recording Mode

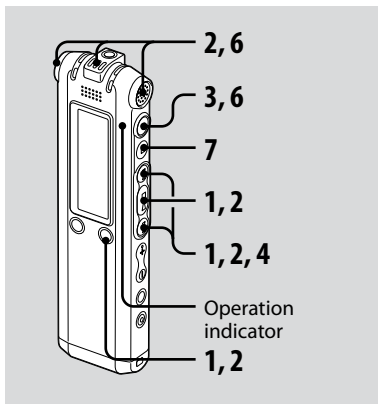

### 1 Select the manual recording mode in the menu.

Select "MANUAL" by pressing **◀▶** or **▶▶** in the "REC LEVEL" menu, and then press **▶■**.

### 2 Select a folder.

① Press **📁**/MENU to display the folder selection window.

② Press **◀▶** or **▶▶** to select the folder in which you want to record messages and then press **▶■**.

### 3 Press and hold ● (record).

The IC recorder enters the record standby mode. When you speak into the microphone, the level meter in the display window moves.

### 4 Adjust the recording level.

Adjust the maximum level of the sound source to about -12 dB on the recording level meter.

If "OVER" is displayed, press **◀▶** or **▶▶** and adjust the recording level down so that "OVER" is not displayed, to prevent sound distortion.

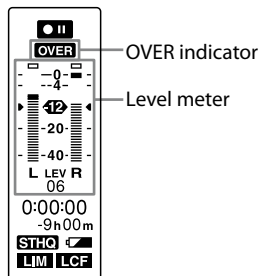



Press and hold ◀◀ or ▶▶ to change the sound level continuously. The sound level is also displayed as a number below the level meter.

**5 Make other settings for recording such as "LCF (LOW CUT)," "LIMITER," etc., in the menu.**

**6 Start recording.**

- ① Press ● (record).  
The OPR indicator lights in red and "REC" is displayed.  
You do not need to press and hold ● while recording.
- ② Speak into the built-in microphone.

**7 Press ■ (stop) to stop recording.**

## Starting to Record Automatically in Response to Sound – the VOR Function

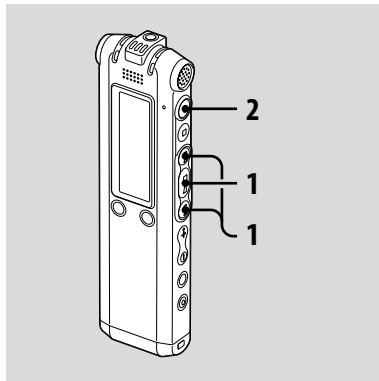

When recording with AUTO AGC, set the VOR (Voice Operated Recording) function to "ON" in the menu (page 50).

- 1 Press **I◀** or **▶I** to set "VOR" to "ON" in the menu, and then press **▶■**.

"VOR" appears in the display window.

- 2 Press **●** (record).

The recording starts when the IC recorder detects sound. The recording pauses when no sound is detected and "VOR" and "●■" flash. When the IC recorder detects sound again, the recording starts again.

### To cancel the VOR function

Set "VOR" to "OFF" in the menu.

#### **■ Note**

The VOR function is affected by the sound around you. Set "MIC SENS" in the menu according to the recording conditions. If recording is not satisfactory after you have changed the microphone sensitivity, or for an important recording, set "VOR" to "OFF" in the menu.

## Adding a Recording to a Previously Recorded Message

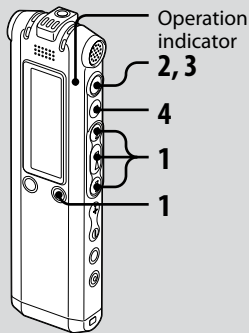

When “ADD/OVER” in the menu is set to “ADD,” you can add a recording to the message being played back. The added recording will be placed after the current message, and will be counted as a part of the message.

- You cannot add a recording to an MP3 file.

During playback of Message 3

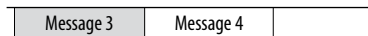

After adding a recording



**1** Press **◀◀** or **▶▶** to set “ADD/OVER” to “ADD” in the menu, and then press **▶■**.

**2** During playback, press **●** (record).

“ADD REC? [REC] TO EXECUTE...” appears.

For details on playback, see page 33.

**3** While “ADD REC? [REC] TO EXECUTE” is displayed, press **●** (record).

The OPR indicator will turn red. The new recording will be added at the end of the current message.

**4** Press **■** (stop) to stop recording.

## Adding an Overwrite Recording during Playback

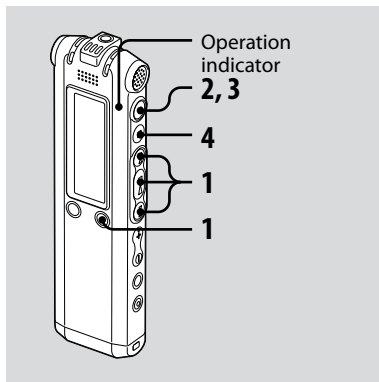

When “ADD/OVER” in the menu is set to “OVER,” you can add an overwrite recording after a selected point in a recorded message. The part of the message after the selected point is deleted.

- You cannot add a recording to an MP3 file.

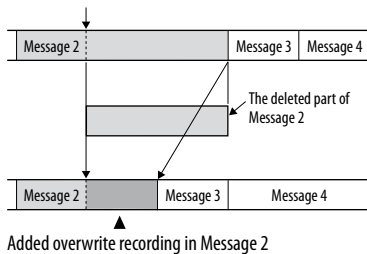

- 1 Press **◀◀** or **▶▶** to set “ADD/OVER” to “OVER” in the menu, and then press **▶■**.
- 2 During playback, press **●** (record). “OVERWRITE REC? [REC] TO EXECUTE” appears.  
For details on playback, see page 33.
- 3 While “OVERWRITE REC? [REC] TO EXECUTE” is displayed, press **●** (record).  
The OPR indicator will turn red. Then recording starts.
- 4 Press **■** (stop) to stop recording.

## Dividing a Message into Two during Recording

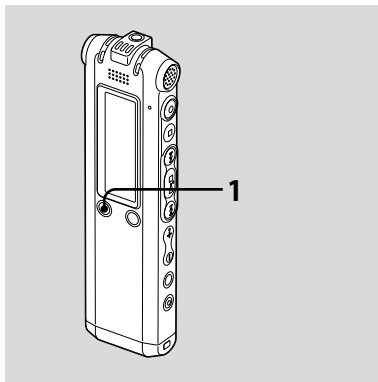

You can divide a message during recording so that the message is divided into two parts and the new message number is added to the newer part of the divided message.

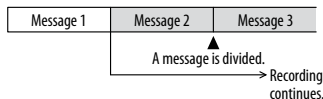

**1 Press DIVIDE/📌 (bookmark) during recording.**

An animation which shows dividing appears below the level meter.

The new message number is added at the point you pressed the button.

The message will be divided into two, while recording continues.

---

## Recording with an External Microphone

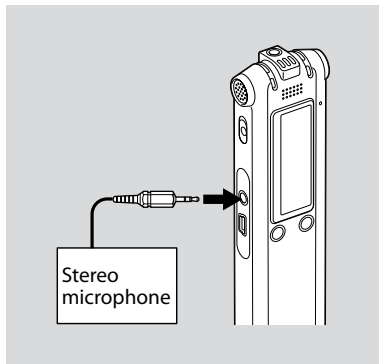

**1 Connect an external microphone to the 📌 (microphone) jack when the IC recorder is in the stop mode.**

"SELECT INPUT" appears in the display window.

- 2 Press **I◀◀** or **▶▶I** to select “MIC IN” and then press **▶■**.
- 3 **Speak into the external microphone and start recording.**

The built-in microphone is automatically cut off.

If the input level is not strong enough, adjust the microphone sensitivity and/or recording level on the IC recorder.

When a plug in power type microphone is connected, power is automatically supplied to the microphone from the IC recorder.

### When the IC recorder is not in the stop mode

Select “MIC IN” using the menu by selecting “DETAIL MENU” - “SELECT INPUT” - “MIC IN” (page 54).

#### Recommended microphones

You can use the Sony ECM-CS10 or ECM-CZ10 electret condenser microphone (not supplied).

## Recording from Other Equipment

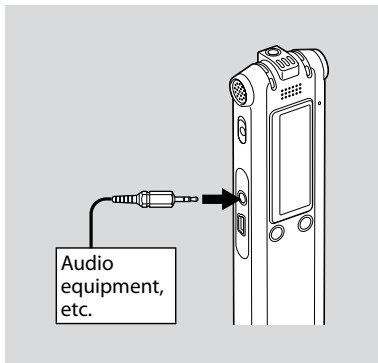

- 1 **Connect other equipment to the IC recorder when the IC recorder is in the stop mode.**

Connect the audio output connector (stereo mini-plug) of other equipment to the  (microphone) jack of the IC recorder using an audio connecting cable\*.

“SELECT INPUT” appears in the display window.

**2** Press **I◀◀** or **▶▶I** to select “AUDIO IN” and then press **▶■**.

**3 Start recording.**

The built-in microphone is automatically cut off and the sound from the connected equipment is recorded.

If the input level is not strong enough, adjust the microphone sensitivity and/or recording level on the IC recorder.

**\* Optional audio connecting cables (not supplied)**

	<b>To the IC recorder</b>	<b>To the other equipment</b>
RK-G139	Stereo mini-plug (without resistor)	Mini-plug (monaural) (without resistor)
RK-G136	Stereo mini-plug (without resistor)	Stereo mini-plug (without resistor)

**When the IC recorder is not in the stop mode**

Select “AUDIO IN” using the menu by selecting “DETAIL MENU” - “SELECT INPUT” - “AUDIO IN” (page 54).

---

**Recording sound from a telephone or a cell phone**

You can use the ECM-TL1 headphone-type electret condenser microphone (not supplied) to record sound from a telephone or a cell phone.

For details on how to make the connection, see the operating instructions supplied with the ECM-TL1 microphone.



## Playing Back Messages

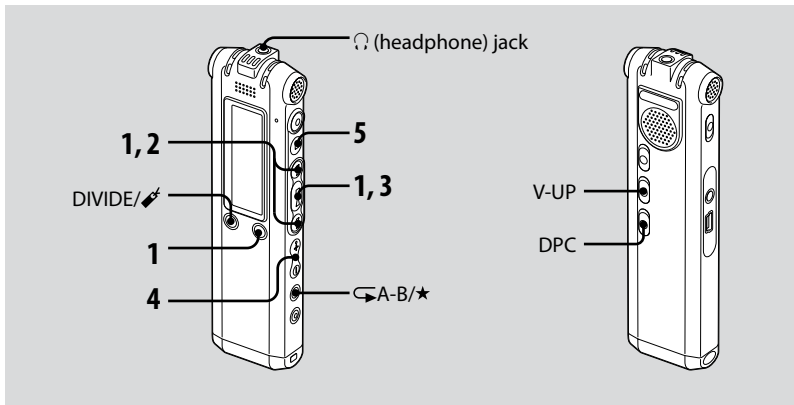

### 1 Select a folder.

- 1 Press /MENU.
- 2 Press or to select the folder and then press .

### 2 Press or to select the message number.

### 3 Press to start playback.

### 4 Adjust the volume with VOL +/-.

### 5 Press to stop playback.

After playing back one message, the IC recorder stops at the beginning of the next message.

## Listening with better sound quality



### • To listen from an ear receiver :



Connect the stereo ear receiver supplied to the  (headphone) jack. The built-in speaker will be automatically disconnected.

### • To listen from an external speaker :

Connect an active or passive speaker (not supplied) to the  (headphone) jack.

## Quickly locating the point you wish to start playback (Easy Search)

When "EASY SEARCH" is set to "ON" (page 51) in the menu, you can quickly locate the point at which you wish to start playback by pressing  or  repeatedly during playback or playback pause.

You can go back approx. 3 seconds by pressing  once, or advance approx. 10 seconds by pressing  once. This function is useful for locating a desired point in a long recording.

## Searching forward/backward during playback (Cue/Review)

• **To search forward (Cue):** Press and hold  during playback and release it at the point you wish to resume playback.

• **To search backward (Review):** Press and hold  during playback and release it at the point you wish to resume playback.

The IC recorder searches at slow speed with playback sound. This is useful to check one word forward or back. Then, if you press and hold the button, the IC recorder starts to search at higher speed. During cue/review, the counter will be displayed, regardless of the setting of "DISPLAY" (page 50).

## When messages are played back to the end of the last message

- When you play back or fast play back to the end of the last message, "MESSAGE END" lights up for 5 seconds and the operation indicator lights up in green. (You cannot hear the playback sound.)
- When "MESSAGE END" and the operation indicator go off, the IC recorder will stop at the beginning of the last message.
- If you press and hold **⏮** while "MESSAGE END" is lit, the messages are played back rapidly, and normal playback will start at the point you release the button.
- If the last message is long and you wish to start playback at a later part of the message, press and hold **⏭** to go to the end of the message and then press **⏮** while "MESSAGE END" is lit to go back to the desired point.
- For messages other than the last one, go to the beginning of the next message and play backward to the desired point.

To	Do this
stop at the current position (Playback Pause function)	Press <b>■</b> (stop) or <b>▶■</b> . To resume playback from that point, press <b>▶■</b> again.
go back to the beginning of the current message*	Press <b>⏮</b> once.**
go back to previous messages	Press <b>⏮</b> repeatedly. (During stop mode, keep the button pressed to go back the messages continuously.)
skip to the next message*	Press <b>⏭</b> once.**
skip to the succeeding messages	Press <b>⏭</b> repeatedly. (During stop mode, keep the button pressed to skip the messages continuously.)

\* If you have set a bookmark on the message, the IC recorder stops at the bookmark.

\*\* These operations are for when "EASY SEARCH" is set to "OFF" (page 51).

## Various playback modes

You can select “1 FILE” playback (one message/file is played back once), “FOLDER” playback (all the messages/files in the selected folder are played back continuously), “ALL” playback (all the recorded messages/files are played back continuously) in the “PLAY MODE” menu (page 51).

## Playing back a message repeatedly

During playback, press and hold ►■ until “↺1” appears. The selected message will be played back repeatedly.

To resume normal playback, press ►■ again.

## Reinforcing the bass sound

Set “EFFECT” to “BASS1” or “BASS2” in the menu (page 51).

---

## Adjusting the playback sound by amplifying inaudible sound – the Digital Voice Up function

When you slide the V-UP switch to “ON,” the low-level part of a recorded message is amplified, allowing you to hear even small voices more easily.

You can set “MAX” or “MID” for “V-UP LEVEL” in the menu (page 56).

## To resume normal playback

Slide the V-UP switch back to “OFF.”

## Adjusting the playback speed – DPC (the Digital Pitch Control function)

When you slide the DPC switch to “ON,” you can adjust the playback speed between +200% and –75% of normal speed in the menu.

The message is played back in natural tones thanks to the digital processing function.

- 1 Slide the DPC switch to “ON.”
- 2 Adjust the playback speed in the “DPC” menu (page 50).

### To resume normal playback

Slide the DPC switch to “OFF.”

## Playing Back a Specified Section Repeatedly – A-B Repeat

- 1 During playback, press  (repeat) A-B/★ (priority) briefly to specify the starting point A.

“A-B B?” is displayed.

- 2 Press  (repeat) A-B/★ (priority) briefly again to specify the finishing point B.

“ A-B” is displayed and the specified section is played back repeatedly.

### To resume normal playback

Press  .

### To change the segment specified for A-B repeat playback

During the A-B Repeat playback, press  A-B/★ (priority) again, and start from step 1, above.

---

## Adding a Bookmark

You can add a bookmark at a point in a message and use it during playback. You can add only one bookmark in each message.

### 1 During playback or stop, press **DIVIDE/📌** (bookmark) for more than one second.

A bookmark is added and "📌" (bookmark) flashes three times. If you add a bookmark to a message that already has a bookmark, the previously added bookmark is deleted and a new bookmark is added at the newly specified point.

## To start playback at the bookmark

Press **⏮** or **⏭** when the IC recorder is in the stop mode. When "📌" (bookmark) flashes once, press **▶■**.

## To delete the bookmark

Set "ERASE BKMRK" to "YES" in the menu (page 53).

### 📌 Notes

- You cannot add a bookmark on MP3 files.
- You cannot add a bookmark at the very beginning or at the very end of the message.

## Playing Back a Message at a Desired Time with an Alarm

You can sound an alarm and start playback of a selected message at a desired time.

You can have the message played back on a specified date, once every week, or at the same time every day.







You can set up to 30 alarms.

### Notes





- When the clock has not been set or no messages are recorded, you cannot set the alarm.
- When  is displayed for the folder indicator, you cannot set the alarm (page 64).
- The alarm sounds even if you set "BEEP" to "OFF" in the menu (page 52).

**1** Select the message you want to play back with an alarm.



**2** Enter the alarm setting mode.

- ① Select "ALARM" in the menu and press  .
- ② Press  or  to select "NEW" and then press  .









**3** Set the alarm date and time.

- ① Press  or  to select "DATE," a day of the week, or "DAILY," and then press  .

② When you select "DATE":

Set the month, day, hour, and minute in sequence, as described in "Step 2: Setting the Clock" on page 17, then press  . "EXECUTING..." and then your settings are displayed.

**When you select a day of the week or "DAILY":**

Press  or  to set the hour and then press  , press  or  to set the minute and then press  . "EXECUTING..." and then your settings are displayed.

The setting process is finished and  (alarm indicator) appears in the display window.

## When the set date and time comes

At the set time, the alarm will sound for about 10 seconds and the selected message will be played back.

When the playback ends, the IC recorder will stop automatically at the beginning of that message.

## To listen to the same message again

Press ►■, and the same will be played back from the beginning.

## To stop the alarm before the playback starts

Press ■ while the alarm sound is heard. You can stop the alarm playback even when the HOLD function is activated.

## To change the alarm setting

- 1 Select "ALARM" – "LIST" in the menu and then press ►■.

The alarm list is displayed.

- 2 Press ◀◀ or ▶▶ to select the item you want to change, and then press ►■.

- 3 Press ◀◀ or ▶▶ to select "EDIT," and then press ►■.

- 4 Select "DATE," a day of the week, or "DAILY," and then press ►■.

- 5 Set the date and time and press ►■.

"EXECUTING..." and then your settings are displayed.



## To cancel the alarm setting

Follow steps 1 and 2 of “To change the alarm setting.” In step 3, select “CANCEL” and press **▶■**. “CANCEL ALARM?” is displayed. Press **◀◀** or **▶▶** to select “YES,” and press **▶■**. The alarm will be cancelled and the alarm indicator will disappear from the display window.

### ■ Notes

- You can set only one alarm each one message.
  - If the alarm time comes while another message is being played back with an alarm, the playback stops and the new message will be played back.
  - If the alarm time comes during recording, the alarm will sound after the recording is finished. “(●)” will flash when the alarm time comes.
  - If more than one alarm time comes during recording only the first message will be played back.
  - When the alarm time comes when the IC recorder is in the menu mode, the alarm will sound and the menu mode will be cancelled.
- If you divide a message you set the alarm for, the alarm setting remains on only the first part of the divided message.
  - The alarm setting will not be cancelled when the alarm playback finishes.
  - When you have set 30 alarms, you cannot set a new one. Cancel an alarm first.
  - If you delete a message on which you have set an alarm, that alarm will be also cancelled.

## Erasing Messages

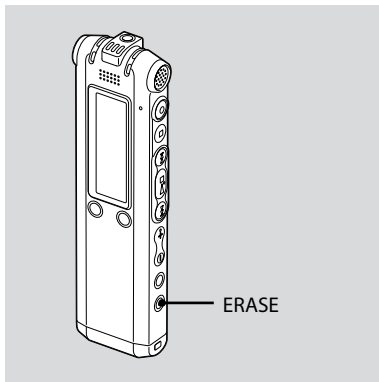

You can erase the recorded messages one by one or all messages in a folder at a time.

### **Note**

Once a recording has been erased, you cannot retrieve it.

## Erasing Messages one by one

You can erase unwanted messages, retaining all other messages. When a message is erased, the remaining messages will advance and be renumbered so that there will be no space between messages.

- 1 Press ERASE while playing back the message you want to erase or press ERASE for more than one second while the IC recorder is in the stop mode.**

The message title, message number, and "ERASE? [ERASE] TO EXECUTE" will be displayed and the message will be played back.

- 2 Press ERASE again while "ERASE? [ERASE] TO EXECUTE" is displayed.**

The message is erased and the remaining messages will be renumbered.

### **To cancel erasing**

Press ■ (stop).

---

## Erasing All Messages in a Folder

Select "ERASE ALL" in the menu (page 53).



# Dividing a Message into Two

You can divide a message during playback, so that the message is divided into two parts and a new message number is added to the newer part of the divided message. By dividing a message, you can easily find the point you want to play back when you make a long recording such as at a meeting. You can divide a message until the total number of messages in the folder reaches 999 or until the total number of messages in the all  folders reaches 1012.

### Notes

- You need a certain amount of space in the memory to divide a message. For more information, see “System Limitations” on page 76.
- If you divide a message with priority mark(s), the priority mark(s) will be added to both parts of the divided message.
- When you divide a message with a title, the newer part of the message will have the same title.

- You cannot divide a message at the very beginning or at the very end of the message, or around bookmarks.
- You cannot divide an MP3 file.

Message 1	Message 2	Message 3	
	 A Message is divided.		
Message 1	Message 2	Message 3	Message 4

The message numbers are incremented.

## 1 During playback, press **DIVIDE**/ (bookmark).

The message title, message number, and “DIVIDE? [DIVIDE] TO EXECUTE” are displayed.

## 2 Press **DIVIDE**/ (bookmark) again.

The message numbers of the following messages will be incremented by one.

## Moving Message to a Different Folder

### Note

When “

- 1 Select the message you want to move.
- 2 Select “MOVE” in the menu and press **▶■**.
- 3 Press **◀◀** or **▶▶** to select the folder that you want to move the message into, and then press **▶■**.

“EXECUTING...” is displayed and the message is moved to the destination folder.

When you move a message to another folder, the original message in the previous folder will be deleted.

### To cancel moving the message

Press **■** (stop) before step 3.

## Adding Priority Mark(s) – the Priority Mark Function

You can add priority marks (★) to important messages. There are four levels, “★★★★” (the most important), “★★★”, “★★”, and no priority mark. You can add priority marks both in the stop mode, and in the playback mode.

- You cannot add priority marks to an MP3 file.

- 1 Select the message you want to mark.
- 2 Press and hold **↶A-B/★** (priority).  
The “★” indicator will flash.
- 3 Press and hold **↶A-B/★** (priority) again to add the priority mark.



Each you press and hold **↶A-B/★**, the priority mark(s) will change as follows:



→ No mark → ★ → ★★ → ★★★ →

# Making Settings for the Menu

- 1 Press and hold /MENU for more than one second to enter the menu mode.

The menu mode window will be displayed.

- 2 Press  or  to select the menu item for which you want to make setting and then press .

- 3 Press  or  to select the setting that you want to set, and then press .

- 4 Press  to exit the menu mode.

### Notes

If you do not press any button for one minute, the menu mode is automatically cancelled and the window will return to the normal display.

### To return to the previous window



Press /MENU during menu mode.

## Menu settings

Menu items	Operation mode (○ : the setting can be made/ — : the setting cannot be made)	Stop mode	Playback mode	Recording mode
<b>Settings</b>				
REC MODE	LP, SP, STLP, ST, STHQ	○	—	—
MIC SENS	LOW, HIGH	○	—	○
LCF (LOW CUT)	ON, OFF	○	—	○
REC LEVEL	AUTO_AGC, MANUAL	○	—	○
VOR	ON, OFF	○	—	○
DISPLAY	ELAPSE, REMAIN, REC DATE	○	○	—
DPC	n% (n=-75 - +200)	○	○	—
EFFECT	BASS1, BASS2, OFF	○	○	—
EASY SEARCH	ON, OFF	○	○	—
PLAY MODE	1 FILE, FOLDER, ALL	○	○	—
ADD/OVER	ADD, OVER, OFF	○	—	—
BEEP	ON OFF	○	—	—
LED	ON, OFF	○	—	—
BACKLIGHT	10 SEC, 60 SEC, OFF	○	—	—
ERASE ALL	ERASE ALL? → YES, NO	○	—	—
ERASE BKM RK	ERASE BOOKMARK? → YES, NO	○	—	—
MOVE	(Folder to be moved)	○	○	—
ALARM	NEW, LIST → EDIT, CANCEL	○	—	—

Menu items	Operation mode (○ : the setting can be made/ — : the setting cannot be made)	Stop mode	Playback mode	Recording mode
Settings				
DETAIL MENU		○	○	○
LIMITER	ON, OFF	○	—	○
SELECT INPUT	MIC IN, AUDIO IN	○	—	○
DATE&TIME	MANUAL, AUTO	○	—	—
FORMAT	ERASE ALL DATA? → YES, NO	○	—	—
USB CHARGE	ON, OFF	○	—	—
V-UP LEVEL	MID, MAX	○	○	—







<b>Menu items</b>	<b>Settings (*: Initial setting)</b>
REC MODE	<p>Sets the recording mode.</p> <p>STHQ*: You can record with high-quality stereo sound.</p> <p>ST: You can record with better sound in stereo.</p> <p>STLP: You can record for a longer time in stereo.</p> <p>SP: You can record with better sound (monaural sound)</p> <p>LP: You can record for a longer time (monaural sound).</p>
MIC SENS	<p>Sets the microphone sensitivity. When "REC LEVEL" is set to "AUTO_AGC," this setting is effective.</p> <p>HIGH *: To record at meeting or in a quiet and/or spacious place.</p> <p>LOW : To record dictation, or record in a noisy place.</p>
LCF (LOW CUT)	<p>Cuts any frequency lower than 200Hz to reduce the roaring noise from wind (Low Cut Filter).</p> <p>OFF*: The LCF function does not work.</p> <p>ON: The LCF function is activated.</p>

<b>Menu items</b>	<b>Settings (*: Initial setting)</b>
<b>REC LEVEL</b>	<p>Sets to record using AGC or to record manually.</p> <p><b>AUTO_AGC*:</b> The recording level is automatically adjusted, and you can record with distortion-free sound. You can set the microphone sensitivity by changing the setting of "MIC SENS."</p> <p><b>MANUAL:</b> You can adjust the recording level manually (page 24).</p>
<b>VOR</b>	<p>Sets the <b>VOR (Voice Operated Recording)</b> function. When "REC LEVEL" is set to "AUTO_AGC," this setting is effective.</p> <p><b>OFF*:</b> The VOR function does not work.</p> <p><b>ON:</b> The VOR function is activated when ● (record) is pressed. Recording starts when the IC recorder detects sound and pauses when no sound is heard, eliminating recording during soundless periods.</p>
<b>DISPLAY</b>	<p>Changes the display mode. (Items shown in the playback/ stop mode)</p> <p><b>ELAPSE*:</b> Elapsed playback time of one message</p> <p><b>REMAIN:</b> Remaining time of one message</p> <p><b>REC DATE:</b> Recorded date and time</p>
<b>DPC</b>	<p>Sets the <b>DPC (Digital Pitch Control)</b> function.</p> <p>When you set the DPC switch to "ON," you can adjust the speed of the playback in a range from +200% to -75%. Set the speed by 10% for + setting and by 5% for - setting.</p> <p>-30%*</p>

<b>Menu items</b>	<b>Settings (*: Initial setting)</b>
<b>EFFECT</b>	<p>Sets whether to emphasize bass sound during playback.</p> <p>OFF*: The EFFECT function does not work.</p> <p>BASS1: The bass sound is emphasized.</p> <p>BASS2: The bass sound is emphasized even more.</p> <p><b>Note</b> When playing back messages using a speaker, the EFFECT function does not work.</p>
<b>EASY SEARCH</b>	<p>Sets the easy search function.</p> <p>OFF*: The easy search function does not work. When you press ◀◀ or ▶▶, a message will be moved forward or backward.</p> <p>ON: You can go forward for about 10 seconds by pressing ▶▶ and go back for about 3 seconds by pressing ◀◀. This function is useful when attempting to locate desired point in a long recording.</p>
<b>PLAY MODE</b>	<p>Sets the playback mode.</p> <p>FOLDER*: Messages in one folder are played back continuously.</p> <p>ALL: All messages are played back continuously.</p> <p>1 FILE: When a message is played back, the IC recorder stops at the beginning of the next message.</p>

<b>Menu items</b>	<b>Settings (*: Initial setting)</b>
ADD/OVER	<p>You can add a recording to a previously recorded message or an overwrite recording during playback.</p> <p>OFF*: You cannot add or overwrite a recording.</p> <p>ADD: You can add a recording.</p> <p>OVER: You can overwrite a recording.</p>
BEEP	<p><b>Sets whether a beep will be heard or not.</b></p> <p>ON*: A beep will sound to indicate that an operation has been accepted.</p> <p>OFF: No beep sound will be heard.</p>
LED	<p><b>Turns the OPR indicator on or off during operation.</b></p> <p>ON*: During recording or playback, the OPR indicator lights or flashes.</p> <p>OFF: The OPR indicator does not light or flash, even during operation.</p> <p><b>Note</b> When the IC recorder is connected to a computer using the USB cable, the OPR indicator lights or flashes even if "LED" is set to "OFF".</p>

<b>Menu items</b>	<b>Settings (*: Initial setting)</b>
BACKLIGHT	<p><b>Turns the backlight in the display window on or off.</b></p> <p>10 SEC*: The backlight in the display window lights up for 10 seconds.</p> <p>60 SEC: The backlight in the display window lights up for 60 seconds.</p> <p>OFF: The backlight in the display window does not light, even during operation.</p>
ERASE ALL	<p><b>All messages in the selected folder will be erased.</b></p> <p>Press /MENU to return to the folder window before erasing the messages and select a folder from which all messages are to be erased, and then go to the menu window and select "YES."</p>
ERASE BKMRK	<p><b>The bookmark of the selected message will be cancelled.</b></p> <p>Press /MENU to return to the folder window before erasing the bookmark and select a folder from which the bookmark is to be erased, and then go to the menu window and select "YES."</p>
MOVE	<p><b>The selected message will be moved to the selected folder.</b></p> <p>Press /MENU to return to the folder window before moving the message and select a folder from which the message is to be moved.</p>

Menu items	Settings (*: Initial setting)
ALARM	<p>Sets the alarm.</p> <p>NEW*: Set DATE for playback, SUN (Sunday), MON (Monday), TUE (Tuesday), WED (Wednesday), THU (Thursday), FRI (Friday), SAT (Saturday), or DAILY.</p> <p>LIST : A list of the message numbers, date, or the days of the week on which the alarm has already been set will be displayed.</p> <p>EDIT : You can change the selected date or day of the week.</p> <p>CANCEL: You can cancel the alarm on the selected date or on a day of the week.</p>
<b>DETAIL MENU</b>	
LIMITER	<p>Sets the input level automatically to prevent the sound distortion that occurs when a sound that is too loud is input.</p> <p>ON*: The LIMITER function is activated.</p> <p>OFF: The LIMITER function is cancelled.</p>
<p><b>Note</b> When "REC LEVEL" is set to "MANUAL," this setting is effective.</p>	
SELECT INPUT	<p>Selects the external input to be recorded that is connected to the  (microphone) jack.</p> <p>MIC IN*: Select when you record messages using an external microphone.</p> <p>AUDIO IN: Select when you record using other equipment.</p>

---

Menu items	Settings (*: Initial setting)
DATE & TIME	<p data-bbox="279 108 414 129">Sets the clock.</p> <p data-bbox="279 134 352 155">AUTO*:</p> <p data-bbox="300 160 911 238">When the IC recorder is connected to a computer that is running the Digital Voice Editor, the clock will be automatically adjusted according to that computer.</p> <p data-bbox="279 243 372 264">MANUAL:</p> <p data-bbox="300 269 932 315">You can set the clock by setting year, month, day, hour, and minute in sequence.</p>
FORMAT	<p data-bbox="279 326 911 378"><b>Sets the formatting of the drive after “ERASE ALL DATA?” has been displayed.</b></p> <p data-bbox="279 383 321 404">NO*:</p> <p data-bbox="300 409 600 429">The drive will not be formatted.</p> <p data-bbox="279 435 321 455">YES:</p> <p data-bbox="300 461 559 481">The drive will be formatted.</p> <p data-bbox="279 502 362 523"><b>Note</b></p> <p data-bbox="279 528 932 603">Use the IC recorder formatting function to format the memory. If you format the IC recorder using your computer, the sound may be interrupted unexpectedly and the recording time may be shortened.</p>

---

---

Menu items	Settings (*: Initial setting)
USB CHARGE	<p>Sets whether batteries will be charged using a USB connection or not.</p> <p>ON*: The batteries will be charged.</p> <p>OFF: The batteries will not be charged.</p> <p><b>Note</b> If you use a USB AC adaptor (not supplied) to connect the IC recorder to the AC outlet, you can charge batteries regardless this setting.</p>
V-UP LEVEL	<p>When the VOICE UP switch is set to "ON," set the sound level to be amplified so that the inaudible low-level part will become more audible.</p> <p>MAX*: You can adjust the VOICE UP level more effectively.</p> <p>MID: You can adjust the VOICE UP level less finely.</p>

---



## Using the Supplied Digital Voice Editor Software

### What You Can Do Using the Digital Voice Editor Software

The Digital Voice Editor software allows you to transfer the messages to your display monitor, to save them on your computer's hard disk, and to play back and edit them.

- Transferring the messages recorded on the IC recorder to your computer
- Saving the messages on your computer's hard disk.
- Viewing, playing, or editing the messages on your computer.
- Transferring messages back to the IC recorder. You can add an MP3 file as it is.
- Sending a voice e-mail message using MAPI e-mail software.

- Using the transcribing keys to play back a message and transcribe it using a word-processor or an editor's window.
- Transcribing your IC recorder message using Dragon NaturallySpeaking® speech-recognition software (Only when Dragon NaturallySpeaking version 5.0 (or higher) Preferred or Professional Edition is installed on your computer).
- Using the CD Recording Tool for DVE, you can play tracks of a CD inserted into the computer's CD drive and save CD tracks onto the PC hard disk as a file format that the Digital Voice Editor supports. Saved files can then be added to an IC recorder using the Digital Voice Editor.

Use of the CD Recording Tool for DVE is limited to the personal purposes.

---

## System Requirements

Your computer and system software must meet the following minimum requirements.

- IBM PC/AT or compatible
  - CPU: 266 MHz Pentium® II processor or higher
  - RAM: 128 MB or more
  - Hard disk space: 70 MB or more depending on the size and number of sound files you store.
  - CD-ROM drive
  - Port: USB port (Hi-Speed USB is supported)
  - Sound board: Windows® XP Media Center Edition 2005, Windows® XP Media Center Edition 2004, Windows® XP Media Center Edition, Windows® XP Professional, Windows® XP Home Edition, Windows® 2000 Professional compatible
  - Display: High color (16 bit) or more and 800 × 480 dots or more
- OS: Microsoft® Windows® XP Media Center Edition Service Pack 2 or higher 2005/Windows® XP Media Center Edition Service Pack 2 or higher 2004/Windows® XP Media Center Edition Service Pack 2 or higher/Windows® XP Professional Service Pack 2 or higher/Windows® XP Home Edition Service Pack 2 or higher/Windows® 2000 Professional Service Pack 4 or higher installation (You cannot use this software with Windows® 95/Windows® 98/Windows® 98 Second Edition/Windows® Millennium Edition/Windows® NT.)

### Notes

- You cannot use the software with a Macintosh machine.
- A handmade computer, a computer whose operating system is installed or upgraded by the user, or a computer with multi-boot operating environment are not supported.

### **Note on transcribing a message**

When you use Dragon NaturallySpeaking® speech-recognition software to transcribe a message, your computer must also meet the system requirements that the Dragon NaturallySpeaking requires.

## Note on sending a voice e-mail

When you use Microsoft® Outlook Express 5.0/5.5/6.0 to send a voice e-mail of a message, your computer must also meet the system requirements that the Outlook Express requires.

## Installing the Software

Install the Digital Voice Editor software in your computer's hard disk.

### Notes

- When you install the Digital Voice Editor, you can create all the compatible file types except for the DVF (TRC) files. (You can play back the DVF (TRC) files.)  
**When installing both types of the Digital Voice Editor, make sure to select overwrite installation to handle all the compatible file formats.**
- Do not connect the IC recorder to the computer before installing the Software. Or do not remove or connect the IC recorder during installing the Software; The IC recorder may not be recognized or the Software may not be installed successfully.
- Be sure to close all running programs before installing the Digital Voice Editor software.
- When installing or uninstalling the software in Windows® 2000 Professional, make sure to log on Windows as the user name of "Administrator."

- When installing or uninstalling the software in Windows® XP Media Center Edition 2005/Windows® XP Media Center Edition 2004/Windows® XP Media Center Edition/Windows® XP Professional/Windows® XP Home Edition, log on as a user name with the "Computer administrator" user account. (To find if the user name has a "Computer administrator" user account, open the "User Accounts" from the "Control Panel" and refer to the section beneath the user name being displayed.)
- When the "Memory Stick Voice Editor 1.0/1.1/1.2/2.0" software has already been installed, installing the supplied software will automatically remove the "Memory Stick Voice Editor" software. (Messages are not removed.)
- After installing, the Microsoft DirectX module is also installed depending on the operation system of your computer. This module is not deleted after uninstalling the software.
- After installing the Digital Voice Editor software, do not install the "Memory Stick Voice Editor 1.0/1.1/1.2/2.0" software. The Digital Voice Editor will not work properly.
- With the supplied software, you can save or edit the messages in the "Memory Stick".

**1 Make sure that the IC recorder is not connected and then turn on your computer and start up Windows.**

**2 Insert the supplied CD-ROM into the CD-ROM drive.**

The installer starts up automatically and the welcome window appears. If the installer does not start up, double click [DVE Setup.exe] in the [English] folder.

**If you have already installed a previous version of the Digital Voice Editor or any version of the “Memory Stick Voice Editor”**

The dialog box to uninstall the previous version may be displayed. (Messages are not removed.) Follow the instructions on the screen to uninstall the software and then the installation of the current version starts.

**3 Follow the displayed instructions.**

When the [Restart] dialog box appears, click [OK] to restart the computer. Now the installation is completed.

**When the dialog box to select the help language is displayed**

Click the desired language you want to use for the help.

**When the dialog box used to input the owner name is displayed**

Input the owner name for privileges and limitations in the Digital Voice Editor usage.

#### **Notes**

- You cannot change the owner name once it is entered. Please write down and keep it for future reference.
- A file recorded from a CD cannot be handled except for the PC where the file is recorded. Handling of a file is limited among the PCs bearing the same owner name input during the Digital Voice Editor installation. If any illegal data modification is attempted, or a file is used beyond the private purposes, the file may become unplayable or the Digital Voice Editor may become inoperable.

#### **Uninstalling the software**

When you wish to uninstall the software, follow the steps below.

**1 Click [Start] and select [Programs], [Sony Digital Voice Editor 3] and then [Uninstall].**

The uninstaller starts up.

**2 Follow the displayed instructions.**

## Note

If you wish to move the software to another drive or directory after it is installed, you need to uninstall the software and then reinstall it. The software does not work properly if you just move the files.

## Tips

- You can also start up the uninstaller by clicking [Start] and then selecting [Settings], [Control Panel], and [Add/Remove Programs].
- Uninstallation does not remove the message files.

## Connecting the IC Recorder to your Computer

You can transfer the IC recorder data onto your computer by connecting the IC recorder to the computer.

Use the USB connecting cable supplied with the IC recorder to connect the USB connectors of the IC recorder and your computer.

The IC recorder is recognized by the computer as soon as the cable is connected. You can connect or disconnect the cable when the IC recorder and the computer are turned on or off.

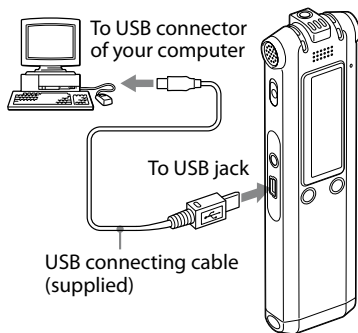

## Notes

- Be sure to install the Digital Voice Editor software before connecting the IC recorder to your computer. Otherwise, a message like [Found New Hardware Wizard] may appear when you connect the IC recorder to your computer. In this case, click [Cancel].
- Do not connect more than two USB devices to your computer. Normal operation will not be guaranteed.
- Use of this IC recorder with a USB hub or a USB extension cable is not guaranteed.
- A malfunction may occur depending on the USB devices connected at any one time.
- Before connecting the IC recorder to the computer, check that batteries are inserted in the IC recorder.

- When you connect the IC recorder to the computer, make sure that the IC recorder is in the stop mode.
- It is recommend that you disconnect the cable from the computer when you do not use the Digital Voice Editor.

## Referring to the Help Files

For details on each operation, refer to the help files.

Help

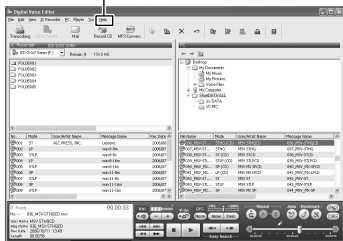

## Playing Back MP3 Files Using the IC Recorder

You can play back MP3 files on your computer using the IC recorder. There are two ways how to copy the MP3 files to the IC recorder; using the Digital Voice Editor software and dragging and dropping from Windows Explorer. The maximum playback time (tracks\*), when playing MP3 files using the IC recorder, is as follows.

48 kbps	128 kbps
11 hr. 20 min. (170 tracks)	4 hr. 15 min. (63 tracks)

\* In the case where tracks of 4 minutes each are transferred to the IC recorder.

---



## Using the Digital Voice Editor Software

**1** Connect the IC recorder to your computer using the supplied USB cable (page 61).

**2** Start the Digital Voice Editor supplied and copy MP files from your computer to the IC recorder.

The IC recorder can recognize up to 511 folders. When there is one file in each folder, you can create up to 340 folders, and when there are 5 folders, you can copy up to 1012 files in total, up to 999 files in one folder.

**3** Remove the IC recorder from your computer, and then press /MENU to select the folder you want.

**4** Press  or  to select a file you want to play, and then press .

**5** Press  to stop playback.

---

## Using Windows Explorer

### Note

When you copy MP3 files using Windows Explorer, rather than the Digital Voice Editor software, you can play back the MP3 files as usually but you cannot add/overwrite the recording, divide files (messages), add bookmarks or add priority marks.

**1** Connect the IC recorder to your computer using the supplied USB cable (page 61).

Open “My Computer” and make sure that a removable disk is recognized newly on the Windows screen.

**2** Drag and drop the folder in which MP3 files are stored to the removable disk.



The IC recorder can recognize up to 500 folders. You can copy up to 999 files in one folder and up 5000 files in total.

- 3 Remove the IC recorder from your computer, and then press **⏏**/MENU to select the folder you want.
- 4 Press **⏪** or **⏩** to select a file you want to play, and then press **▶**.
- 5 Press **■** to stop playback.

## Construction of folders and files

The folders and files are displayed on the computer screen as shown on the right.

The folder indicators in the display window of the IC recorder are as follows:

-  Folders copied using the Digital Voice Editor software
-  Folders copied without the Digital Voice Editor software

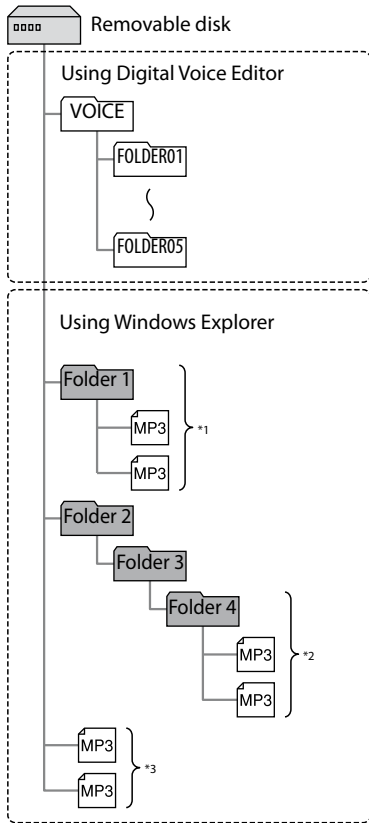



- <sup>\*1</sup> The name of the folder in which MP3 files are stored will be displayed on the IC recorder as it is, so it is convenient if you put an easy-to-control name to the folder in advance.
- <sup>\*2</sup> The IC recorder can recognize up to third level on the removable disk, that is, Folder 4 shown in the figure.
- <sup>\*3</sup> If you copy MP3 files separately, they are classified in "NO FOLDER."

**Note**

You cannot copy 511 or more folders (except VOICE folders) or files to a removable disk depending on system limitations.

---

## Using the IC Recorder as a USB Mass Storage Device



When the IC recorder is connected to your computer using a USB cable, image data or text data on the computer, as well as messages or files recorded using the IC recorder can be temporarily stored in the IC recorder.

# Troubleshooting

Before taking the IC recorder for repair, check the following sections. Should any problem persist after you have made these checks, consult your nearest Sony dealer.

## IC Recorder

Symptom	Remedy
The IC recorder cannot be turned off with a display in the window.	<ul style="list-style-type: none"><li>• The IC recorder is not equipped with a power on/off switch. The display always appears in the window. The power consumption for the display is very small and will not have any appreciable influence on the battery life. You can turn off the display by sliding the HOLD switch in the direction of the arrow. The display will also be turned off after 10 minutes if you do not press any button.</li></ul>
The IC recorder does not operate.	<ul style="list-style-type: none"><li>• The batteries have been inserted with incorrect polarity (page 13).</li><li>• The batteries are weak (page 14).</li><li>• The buttons are locked with the HOLD switch (page 9). (If you press any button, "HOLD" will flash for 3 seconds.)</li></ul>
No sound comes from the speaker.	<ul style="list-style-type: none"><li>• The volume is turned down completely (page 33).</li><li>• Headphones are plugged in (page 34).</li></ul>
Sound comes from the speaker even when the headphones are plugged in.	<ul style="list-style-type: none"><li>• If you plug in the headphones not securely during playback, the sound may come from the speaker. Unplug the headphones and then insert them securely.</li></ul>
The operation indicator does not light.	<ul style="list-style-type: none"><li>• "LED" is set to "OFF" (page 52). Display the menu and set "LED" to "ON".</li></ul>
"MEMORY FULL" is displayed and you cannot start recording.	<ul style="list-style-type: none"><li>• The memory is full. Erase some of the messages (page 42) or erase all the messages after you store them on your computer.</li></ul>

Symptom	Remedy
"FILE FULL" is displayed and you cannot operate the IC recorder.	<ul style="list-style-type: none"><li>• 999 messages have been recorded in the selected folder or 1012 messages (when there are 5 folders) in total have been recorded. Therefore you cannot record another message, or move or divide a message. Erase some of the messages (page 42) or erase all the messages after you store them on your computer.</li></ul>
You cannot add a recording or an overwrite recording.	<ul style="list-style-type: none"><li>• As a factory setting, "ADD/OVER" in the menu is set to "OFF." Display the menu and change "ADD/OVER" to "ADD" or "OVER" (page 52).</li><li>• The remaining memory capacity is insufficient. The overwritten part will be deleted after the overwriting part finishes recording. Therefore, you can only overwrite within the remaining recording time.</li><li>• You cannot add a recording or an overwrite recording to MP3 files.</li></ul>
Recording is interrupted.	<ul style="list-style-type: none"><li>• The advanced VOR function (page 25) is activated. Set "VOR" to "OFF" in the menu (page 50).</li></ul>
Noise is heard.	<ul style="list-style-type: none"><li>• An object, such as your finger, etc., accidentally rubbed or scratched the IC recorder during recording so that noise was recorded.</li><li>• The IC recorder was placed near an AC power source, a fluorescent lamp or a mobile phone during recording or playback.</li><li>• Plug of the connected microphone was dirty when recording. Clean the plug.</li><li>• The  (headphones) plug is dirty. Clean the plug.</li></ul>
Recording level is low.	<ul style="list-style-type: none"><li>• "MIC SENS" (microphone sensitivity) is set to . Display the menu and set "MIC SENS" to  (page 49).</li><li>• If it is difficult to hear small sound of a recorded message, slide VOICE UP to "ON" (page 36). Playback sound may become more audible.</li></ul>

Symptom	Remedy
Playback speed is too fast or too slow.	<ul style="list-style-type: none"> <li>The playback speed is adjusted in DPC. Slide the DPC switch to "OFF" or display the menu and adjust the speed in DPC again (pages 37, 50).</li> </ul>
"--:--" is displayed.	<ul style="list-style-type: none"> <li>You have not set the clock (page 17).</li> </ul>
"--Y--M--D" or "--:--" is displayed on the REC DATE display.	<ul style="list-style-type: none"> <li>The date of recording will not be displayed if you recorded the message when the clock was not set.</li> </ul>
There are fewer menu items displayed in the menu mode.	<ul style="list-style-type: none"> <li>The menu items displayed are different depending on the operation modes (stop mode, playback mode, and recording mode) (pages 47, 48).</li> </ul>
The remaining time displayed in the display window is shorter than that displayed in the supplied Digital Voice Editor software.	<ul style="list-style-type: none"> <li>The IC recorder requires a certain amount of memory for system operation. That amount is subtracted from the remaining time, which is the reason for the difference.</li> </ul>
The battery life is short.	<ul style="list-style-type: none"> <li>The battery life on pages 15 and 16 is based on playback with the medium volume level (using Sony alkaline batteries LR03 (SG)). The battery life may shorten depending on the operation of the IC recorder.</li> </ul>
There is no battery power remaining after you have left the batteries inserted for long time without using the IC recorder.	<ul style="list-style-type: none"> <li>Even if you do not use the IC recorder, the batteries are consumed slightly. The battery life in this case varies depending on humidity or other environmental conditions. Usually, the batteries last two or three months. If you do not intend to use the IC recorder for an extended period of time, it is recommended that you remove the batteries.</li> </ul>

Symptom	Remedy
The charging indicator is not displayed.	<ul style="list-style-type: none"><li>• You are not using rechargeable batteries.</li><li>• Rechargeable batteries have been inserted with incorrect polarity.</li><li>• The USB cable is not connected properly.</li><li>• “USB CHARGE” of “DETAIL MENU” is set to “OFF” in the menu. To charge the batteries using your computer, set it to “ON.”</li></ul>
The charging indicator disappears in the middle of charging.	<ul style="list-style-type: none"><li>• Rechargeable batteries other than NH-AAA have been inserted.</li><li>• The rechargeable batteries have deteriorated.</li></ul>
“COLD” or “HOT” is flashing instead of the remaining battery/charging indicator.	<ul style="list-style-type: none"><li>• The environmental temperature is out of the range for charging. Charge the batteries in an environment with a temperature of 5 °C – 35 °C.</li></ul>
The battery life of the rechargeable batteries is short.	<ul style="list-style-type: none"><li>• You are using the rechargeable batteries in an environment with a temperature of under 5 °C. Charge the batteries in an environment with a temperature of 5 °C – 35 °C.</li><li>• The IC recorder has not been used for a certain time. Charge and discharge the rechargeable batteries using the IC recorder several times.</li><li>• Replace the old ones with new rechargeable batteries.</li><li>• The battery indicator is displayed only for a short time, however, the rechargeable batteries are not charged completely. It takes about 4 hours to fully charge exhausted batteries.</li></ul>
The changed menu setting does not function.	<ul style="list-style-type: none"><li>• If the batteries are removed just after the menu setting is changed, or the menu setting is changed using “IC Recorder Setting” of the Digital Voice Editor software with the exhausted batteries inserted, the menu setting may not function.</li></ul>

<b>Symptom</b>	<b>Remedy</b>
The "UPDATING DATABASE" display does not disappear.	<ul style="list-style-type: none"> <li>• If the IC recorder is required to process excessive amount of data, "UPDATING DATABASE" may be displayed for an extended period of time. This is not a malfunction of the IC recorder. Wait until the message disappears.</li> </ul>
The IC recorder does not operate correctly.	<ul style="list-style-type: none"> <li>• Take out the batteries and insert them again (page 13).</li> </ul>
You cannot connect the IC recorder to a computer.	<ul style="list-style-type: none"> <li>• Refer to the help files of the Digital Voice Editor3 software.</li> </ul>
The IC recorder does not operate.	<ul style="list-style-type: none"> <li>• You may have formatted the memory of the IC recorder using the computer. Use the IC recorder formatting function to format the memory (page 55).</li> </ul>

Please note that recorded messages may be erased during service or repair work.

## **Digital Voice Editor**

Refer to the Help files of the Digital Voice Editor software, too.

<b>Symptom</b>	<b>Remedy</b>
The Digital Voice Editor software cannot be installed.	<ul style="list-style-type: none"> <li>• The free disk or memory space on the computer is too small. Check the hard disk and memory space.</li> <li>• You are trying to install the software into the operating system that the Digital Voice Editor software does not support.</li> <li>• In Windows® XP Media Center Edition 2005/Windows® XP Media Center Edition 2004/Windows® XP Media Center Edition/Windows® XP Professional/Windows® XP Home Edition, you log on as a user name belonging to a user account with limitations. Make sure to log on as a user name with the "Computer administrator" user account.</li> <li>• In Windows® 2000 Professional, make sure to log on as the user name of "Administrator."</li> </ul>

Symptom	Remedy
The IC recorder or “Memory Stick” cannot be properly connected.	<ul style="list-style-type: none"><li>• Check that the installation of the software has been successful. Also check the connection as follows:<ul style="list-style-type: none"><li>– When using an external USB hub, connect the IC recorder directly to the computer.</li><li>– Disconnect and then connect the cable with the IC recorder.</li><li>– Connect the IC recorder to another USB connector.</li></ul></li><li>• Your computer may be in the system standby/hibernate mode. Do not let your computer enter into the system standby/hibernate mode while being connected to the IC recorder.</li></ul>
The IC recorder does not operate.	<ul style="list-style-type: none"><li>• You may format the memory of the IC recorder. Use the IC recorder formatting function to format the memory.</li></ul>
Messages cannot be played back./Playback sound volume is too low.	<ul style="list-style-type: none"><li>• No sound board is installed.</li><li>• No speaker is built-in or connected to the computer.</li><li>• The volume of the sound is turned down.</li><li>• Turn up the volume on the computer. (Refer to the instruction manual of the computer.)</li><li>• The volume of WAV files can be changed and saved using the “Increase Volume” feature of the Microsoft Sound Recorder.</li></ul>
Saved message files cannot be played back or edited.	<ul style="list-style-type: none"><li>• You cannot play back a message whose file format the Digital Voice Editor software does not support. Depending on the file format, you cannot use part of editorial features of the software.</li></ul>
Counter or slider moves incorrectly. There is noise.	<ul style="list-style-type: none"><li>• This happens when you play back messages that you divided, combined, overwrote, or added a recording. Save a message in the hard disk first, and then add it to the IC recorder. Select the saving file format that suits the IC recorder you use.</li></ul>
Operation is slow when there are many messages.	<ul style="list-style-type: none"><li>• When the total number of messages increases, the operation becomes slower, regardless of the length of the recording time.</li></ul>

<b>Symptom</b>	<b>Remedy</b>
Display does not work during saving, adding, or deleting of messages.	<ul style="list-style-type: none"><li>• It takes a longer time to copy or delete long messages. After completing operations, the display works normally.</li></ul>
It takes too long to convert a file format.	<ul style="list-style-type: none"><li>• The time required for file conversion becomes longer as the file size is bigger.</li></ul>
The software 'hangs' when the Digital Voice Editor software starts up.	<ul style="list-style-type: none"><li>• Do not disconnect the connector of the IC recorder while the computer is communicating with the IC recorder. Otherwise the computer operations become unstable or the data inside the IC recorder may be damaged.</li><li>• There may be conflict between the software and other driver or application.</li><li>• Do not install the "Memory Stick Voice Editor" software and the Digital Voice Editor Ver. 2x software after you installed the Digital Voice Editor software. The Digital Voice Editor software may not operate properly.</li></ul>



---

## Error Messages (IC recorder)

---

<b>Error message</b>	<b>Cause/Remedy</b>
BATTERY LOW	<ul style="list-style-type: none"><li>• You cannot format the memory or erase all the files in a folder because of insufficient battery power. Prepare new batteries to replace the current ones.</li></ul>
LOW BATTERY	<ul style="list-style-type: none"><li>• Batteries are exhausted. Replace the old batteries with new ones.</li></ul>
MEMORY FULL	<ul style="list-style-type: none"><li>• The remaining memory capacity of the IC recorder is insufficient. Erase some messages before recording.</li></ul>
FILE FULL	<ul style="list-style-type: none"><li>• When there are already 999 messages in the selected folder or the total number of the file stored in the IC recorder becomes maximum, you cannot divide the message. Erase some messages before dividing a message.</li></ul>
FILE DAMAGED	<ul style="list-style-type: none"><li>• You cannot play or edit messages, because the data of the selected file is damaged.</li></ul>
FORMAT ERROR	<ul style="list-style-type: none"><li>• The IC recorder cannot be turned on using the computer because there is no copy of the control file required for operation. Format the IC recorder using the formatting function in the menu.</li></ul>
PROCESS ERROR	<ul style="list-style-type: none"><li>• The IC recorder failed in memory access. Remove and then re-insert the batteries.</li><li>• Save a backup copy of your data and format the IC recorder using the menu.</li></ul>

---

<b>Error message</b>	<b>Cause/Remedy</b>
SET DATE&TIME	<ul style="list-style-type: none"> <li>• Set the clock; otherwise, you cannot set the alarm.</li> </ul>
SET ADD/OVERWRITE	<ul style="list-style-type: none"> <li>• “ADD/OVER” in the menu is set to “OFF.” You cannot add a recording or an overwrite recording.</li> </ul>
NO FILE	<ul style="list-style-type: none"> <li>• The selected folder does not have any messages. You cannot add priority marks, bookmarks, set the alarm, etc., because of this.</li> </ul>
ALREADY SET	<ul style="list-style-type: none"> <li>• You set the alarm to play back a message at a date and time previously set on another message. Change the alarm setting.</li> </ul>
PAST DATE/TIME	<ul style="list-style-type: none"> <li>• You set the alarm when the time has already passed. Check it and set the appropriate date and time.</li> </ul>
NO SETTING	<ul style="list-style-type: none"> <li>• If you have not set the alarm, the alarm list will not be displayed. Make the alarm setting for “NEW.”</li> <li>• If you have not set any bookmark on a message, you cannot cancel it.</li> </ul>
FILE PROTECTED	<ul style="list-style-type: none"> <li>• The selected message is protected and is now a “Reading only” file. You cannot add priority marks or bookmarks, divide a message, add a recording, or an overwrite recording. Cancel “Reading only” on your computer to edit the message using the IC recorder.</li> </ul>
UNKNOWN DATA	<ul style="list-style-type: none"> <li>• The data does not have a file format which the IC recorder supports.</li> </ul>

<b>Error message</b>	<b>Cause/Remedy</b>
CANNOT OPERATE	<ul style="list-style-type: none"> <li>• If the selected file is an MP3 file, you cannot add priority marks or bookmarks, divide a message, add a recording, or an overwrite recording.</li> <li>• You cannot move a message, because there is more than one folder that has files with same name. Change the file names.</li> </ul>
AUTO_AGC SETTING ONLY	• "REC LEVEL" in the menu is set to "MANUAL."The VOR function does not work and you cannot set the microphone sensitivity.
MANUAL SETTING ONLY	• "REC LEVEL" in the menu is set to "AUTO_AGC."The LIMITER function does not work.
CHANGE FOLDER	• If there are no MP3 files in the  folder, no folders are displayed in the display window, therefore, the folder setting will be changed.
FULL SETTING	• You can set up to 30 alarms. Cancel unwanted alarms.
SYSTEM ERROR	• A system error other than the above has occurred. Remove the batteries and re-insert them.

---

## System Limitations

There are some system limitations of the IC recorder. Troubles as mentioned below are not malfunctions of the IC recorder.

Symptom	Cause/Remedy
You cannot record messages up to the maximum recording time.	<ul style="list-style-type: none"><li>• If you record messages in a mixture of STHQ, ST, STLP, SP and LP modes, the recordable time varies from the maximum STHQ mode recording time to the maximum LP mode recording time.</li><li>• The sum of the number on the counter (elapsed recording time) and the remaining recording time may be less than the IC recorder's maximum recording time.</li></ul>
You cannot divide a message.	<ul style="list-style-type: none"><li>• You cannot divide a message in a folder which has 999 messages.</li><li>• You cannot divide MP3 files.</li><li>• You cannot divide at the beginning of a message or at the end of a message, or around bookmarks.</li></ul>
You cannot display MP3 files in order.	<ul style="list-style-type: none"><li>• If you have transferred MP3 files using Windows Explorer, those files may not be copied in order of transfer because of the limitations of Windows.</li><li>• When you want to display the files you transferred in order, it is recommended that you use the supplied "Digital Voice Editor" software.</li></ul>
You cannot make the A-B repeat setting.	<ul style="list-style-type: none"><li>• If messages on which bookmarks have been added using other IC recorders are copied to this IC recorder, the A-B repeat setting may not be made. Cancel the bookmarks first, and then make the A-B repeat setting.</li></ul>
You cannot enter lower-case characters.	<ul style="list-style-type: none"><li>• Depending on the combination of the characters used for the folder name that was made on Windows Explorer, those characters may change to all capitals.</li></ul>

## Recording with Other Equipment

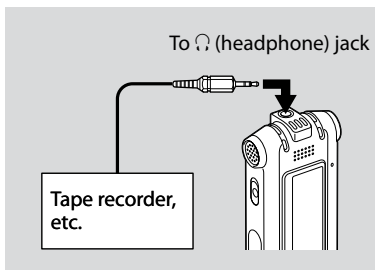

To record the sound of the IC recorder with other equipment, connect the ♪ (headphone) jack of the IC recorder to the audio input connector (minijack, stereo) of other equipment using an audio connecting cable\*.

\* Optional audio connecting cables (not supplied)

	To the IC recorder	To the other equipment
RK-G139	Stereo mini-plug (without resistor)	Mini-plug (monaural) (without resistor)
RK-G136	Stereo mini-plug (without resistor)	Stereo mini-plug (without resistor)

## Using a USB AC Adaptor (not supplied)

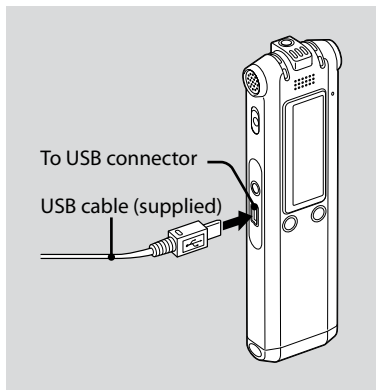

You can charge the rechargeable batteries (not supplied) by connecting the IC recorder to an AC outlet using a USB AC adaptor (not supplied). You can charge the batteries while you are using the IC recorder, so that it is useful when you want to record for a long time.

- 1 Connect the USB cable supplied to the USB connector of the IC recorder.
- 2 Connect a USB AC adaptor (not supplied) to the USB cable.
- 3 Connect the USB AC adaptor to an AC outlet.

While the batteries are charging, "CONNECTING" and the battery indicator are displayed in an animation.

When the battery indicator indicates "FULL", charging is completed. (Charging time: approx. 4 hours\*)

When you use the IC recorder for the first time, or after you have not used the IC recorder for a certain time, it is recommended that you charge the batteries repeatedly until "FULL" is displayed.

If the battery indicator is not displayed, charging has not been done properly. Proceed from step 1 again.

\* This is an approximation for the time it takes to charge from no remaining battery power to full battery power at room temperature. It varies depending on the remaining power and the condition of the batteries. It also takes more time if the temperature of the batteries is low, or if the batteries are changed while you are transferring data to the IC recorder.

## Notes

- While **COLD** or **HOT** is being displayed instead of the remaining battery/charging indicator, you cannot charge the batteries. Charge the batteries in an environment with a temperature of 5 °C – 35 °C.
- You cannot charge the batteries during playback through an internal speaker even when you connect the IC recorder to a wall outlet using a USB AC adaptor.
- While recording (the operation indicator lights or flashes in red) or accessing data (the operation indicator flashes in orange and "UPDATING DATABASE..." is displayed), do not disconnect the USB AC adaptor from an AC outlet. Doing so may damage the data. If the IC recorder is required to process excessive amount of data, "UPDATING DATABASE..." may be displayed for an extended period of time. This is not a malfunction of the IC recorder. Wait until the message disappears from the display window.

---

## Precautions

### On power

- Operate the unit only on 3.0 V or 2.4 V DC. Use two LR 03 (size AAA) alkaline batteries or two NH-AAA rechargeable batteries.

### On safety

- Do not operate the unit while driving, cycling or operating any motorized vehicle.

### On handling

- Do not leave the unit in a location near heat sources, or in a place subject to direct sunlight, excessive dust or mechanical shock.
- Should any solid object or liquid fall into the unit, remove the batteries and have the unit checked by qualified personnel before operating it any further.

## On noise

- Noise may be heard when the unit is placed near an AC power source, a fluorescent lamp or a mobile phone during recording or playback.
- Noise may be recorded when an object, such as your finger, etc., rubs or scratches the unit during recording.

## On maintenance

- To clean the exterior, use a soft cloth slightly moistened in water. Do not use alcohol, benzene or thinner.

If you have any questions or problems concerning your unit, please consult your nearest Sony dealer.

### Backup recommendations

To avoid potential risk of data loss caused by accidental operation or malfunction of the IC recorder, we recommend that you save a backup copy of your recorded messages on a tape recorder or to a computer, etc.

---

## Specifications

### Capacity (User available capacity)

256MB=249,462,784Byte

Actual usable capacity may be smaller.

### Recording time

See page 23.

### Frequency range

- STHQ : 80 Hz - 20,000 Hz
- ST : 80 Hz - 16,500 Hz
- STLP : 80 Hz - 7,000 Hz
- SP : 80 Hz - 6,000 Hz
- LP : 80 Hz - 3,500 Hz

### Bit rates and sampling frequencies for MP3 files

MPEG Ver. 1 Layer 3:

Sampling frequencies: 32, 44.1, 48 kHz

Bit rates: 32, 40, 48, 56, 64, 80, 96, 112, 128, 160, 192, 224, 256, 320 kbps, VBR

MPEG Ver. 2 Layer 3:

Sampling frequencies: 16, 22.05, 24 kHz

Bit rates: 32, 40, 48, 56, 64, 80, 96, 112, 128, 144, 160 kbps, VBR

### Speaker

Approx. 16 mm (21/32 in.) dia.

### Power output

150 mW



## Input/Output

- Microphone jack (minijack, stereo)
  - input for plug in power, minimum input level 0.6 mV, 3 kilohms or lower impedance microphone
- Headphone jack (minijack, stereo)
  - output for 8 - 300 ohms headphones
- USB connector

## Playback speed control

+200% to -75% (DPC)

## Power requirements

Two LR03 (size AAA) alkaline batteries: 3.0 V DC

Two NH-AAA rechargeable batteries: 2.4 V DC

## Operating temperature

5°C - 35°C (41°F - 95°F)

## Dimensions (w/h/d) (not incl. projecting parts and controls)(JEITA)\*

30.8 × 119.3 × 14.9 mm (1 1/4 × 4 3/4 × 19/32 in.)

## Mass (incl. batteries)(JEITA)\*

70 g (2.47 oz)

\* Measured value by the standard of JEITA (Japan Electronics and Information Technology and Industries Association)

## Supplied accessories

See page 7.

## Optional accessories

Battery charger BCG-34HE

Active speaker SRS-T88, SRS-T80

Electret condenser microphone ECM-CS10, ECM-CZ10, ECM-TL1

Audio connecting cable RK-G136HG, RK-G139HG

USB AC adaptor AC-U50A.

Your dealer may not handle some of the above listed optional accessories. Please ask the dealer for detailed information.

Design and specifications are subject to change without notice.

---

# Index

## Symbols

☞ (repeat) A-B/★ (priority) .....8

## A

A-B Repeat .....37  
Adding an Overwrite Recording .....28  
Adding a Recording .....26  
ADD/OVER .....52  
ALARM .....54  
Alarm ..... 10, 12, 39

## B

BACKLIGHT .....53  
Batteries .....7, 13  
Battery life .....15  
BEEP .....52  
Bookmark .....10, 38  
Built-in microphones .....8

## C

Connecting the IC Recorder to your  
Computer .....61

## D

DATE & TIME .....55  
DCP .....37  
DETAIL MENU .....54  
Digital Voice Editor .....7, 57  
Installing .....59

Digital Voice Up .....36  
DIRECTNL .....9, 20  
DIRECTNL switch .....19, 23  
DISPLAY .....50  
Dividing a Message .....29, 44  
DPC .....9, 50

## E

EASY SEARCH .....51  
EFFECT .....51  
ERASE ALL .....53  
ERASE BKMRK .....53  
Erasing Messages .....42  
Error Messages .....73

## F

FORMAT .....55

## H

HOLD .....9

## I

Index to Parts and Controls .....8  
    Display during playback and stop .....10  
    Display during recording .....11  
    Display window .....10  
    Front .....8  
    Rear .....9

## L

LCF (LOW CUT) .....19, 49  
LCF (Low Cut Filter) .....12

LED.....	52
LIM (limiter) .....	12
LIMITER.....	19, 54
LP .....	11, 23

## **M**

Manual Recording Mode.....	24
Menu.....	46
Microphone sensitivity.....	11, 12
MIC SENS.....	19, 20, 49
Monitoring the recording .....	23
MOVE.....	53
Moving Message.....	45
MP3 .....	11

## **P**

Playing Back Message.....	33
Playing Back MP3.....	62
PLAY MODE .....	51
Precautions.....	79
Priority Mark(s).....	45
Priority marks.....	10

## **R**

REC LEVEL.....	19, 50
REC MODE.....	49
Recording Messages.....	21
Recording mode .....	23
Recording time .....	23
Recording with an External Microphone.....	30

Recording with Other Equipment .....	77
Record standby mode.....	24

## **S**

SELECT INPUT.....	54
Setting the Clock .....	17
SP.....	11, 23
Specifications.....	80
ST.....	11, 23
STHQ.....	11, 23
STLP .....	11, 23
System Limitations .....	76

## **T**

Troubleshooting.....	66
Digital Voice Editor .....	70
IC Recorder.....	66

## **U**

USB AC Adaptor.....	78
USB CHARGE.....	56
USB Mass Storage Device.....	65

## **V**

V-UP .....	9
V-UP LEVEL.....	56
VOR.....	25, 50



Printed on 70% or more recycled paper using VOC (Volatile Organic Compound)-free vegetable oil based ink.

Printed in China



\* 2 8 9 4 3 5 3 5 2 \* (1)